

Rectangular [14P] Half Locking & Locking Type

Unit:mm

14Pin

Receptacle Model No.	Mate Plug (Receptacle) Model No.
TCX3081	TCX3128-110110
	TCX3128-110100
	TCX3080-510310
	TCX3080-510300
	TCX3084
	TCX3082

Socket Model No.	Mate Plug (Receptacle) Model No.
TCX3085	TCX3128-110110
	TCX3080-510310
	TCX3084
TCX3083	TCX3128-110100
	TCX3080-510300

TCX3081

SMT Type Right Angle Receptacle

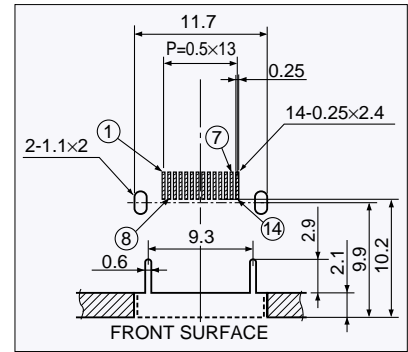
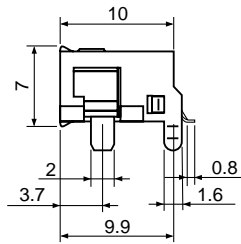
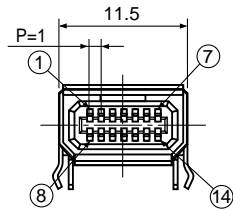
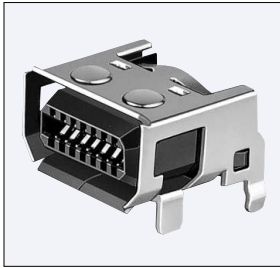

PCB Layout

TCX3085

Assembly Type Straight Socket with Cable



Half Lock Type

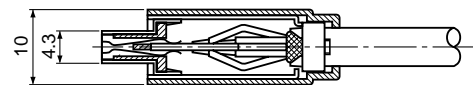
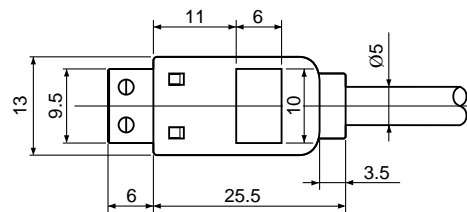
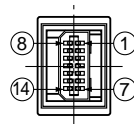

TCX3083

Assembly Type Straight Socket with Cable



Lock Type

